

1T8313EL80 | CCTEVO DOWNLIGHT 160

Recessed LED Downlight in a trim version

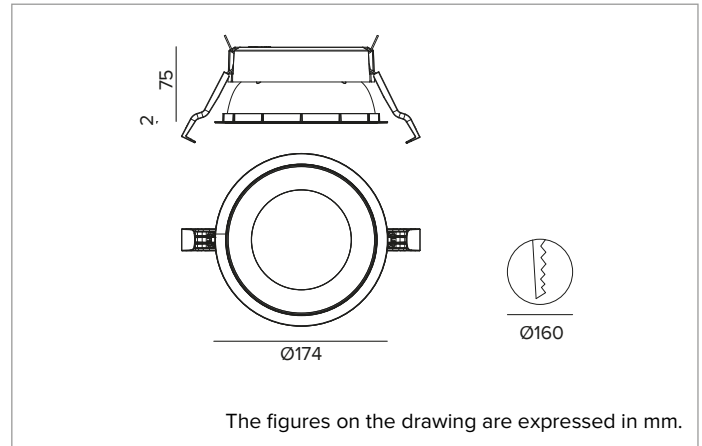

	4000K	H(m)	D(m)	E _{max} (lx)
	Ra80		89°	
Fixture Power	34W	1	1.98	2499
Source Flux	5280lm	2	3.95	625
Fixture Flux	4395lm	3	5.93	278
Efficacy	130lm/W	4	7.90	156
TS1571	I _{max} =473cd/klm	I _{max}	2499cd	5
			9.88	100



SOURCE

High efficiency Chip on Board LED Ra80.

Energy efficiency class: D

Nominal power: 30W

Nominal flux: 5280lm

Colour rendering index: 80

Rf: 82

Rg: 95

CCT nominal: 4000K

Lifetime (L80/B10): >50000h tq +25°C

ILLUMINOTECHNICAL CHARACTERISTICS

VWFL Optic for wide coverage and excellent uniformity of luminance. Optic with high luminous efficiency composed of a thermoplastic reflector with reflective metallisation and a protective anti-scratch coating, a holographic acrylic diffuser screen and a highly reflective white thermoplastic internal recuperator. IP54 protection for the visible parts of the installed fixture.

Optic: REFLECTOR

Beam angles: VWFL

Optical efficiency: 83%

Fixture flux: 4395lm

Luminous efficacy: 130lm/W

Photobiological safety: Compliant with RG1 low risk group

MECHANICAL CHARACTERISTICS

Die-cast black painted anodised aluminium heat sink. Reflective metallised thermoplastic material reflector with high luminous efficiency and visual comfort. Silicone sealing kit for water and dust protection. Trim version with an integrated white ring.

Colour and finish: Plaster white

Weight: 0.8Kg

Version: TRIM

Degree of protection: IP20 for recessed part

Degree of protection: IP54 for exposed part

ELECTRICAL CHARACTERISTICS

Integrated electronic ON-OFF driver. Luminaire compliant with EN 60598-2-22 for power supply from a centralised emergency system CPSS (Central Power Supply System), not incorporated in the luminaire - high risk areas excluded. The default power and flux are 100% in AC and 100% in DC.

Fixture Power: 34W

Power supply: 220-240Vac 50/60Hz

Insulation Class: CLASS 2

Type of driver / Control: ON-OFF

Driver included: YES

Class F: YES

SAFE FLICKER: PstLM=<1 and SVM=<0.4 (IEC TR 61547-1 and IEC TR 63158), to ensure a more comfortable and safe light

Ambient temperature: 0°C / +25°C

INSTALLATION

Quick tool-free mounting system for false ceiling installation from 0.5 to 30mm.

NOTES

110-277Vac version available on request.

WARRANTY

5 years.

WARNING

Luminaire designed for disposal/recycling at end-of-life. Replaceable (LED only) light source by a professional. Replaceable control gear by a professional.

Due to the technological evolution of the electronic components, the data provided may be updated, and as such, confirmation must be requested during the order process.

Luminous flux and power supply have +/-10% tolerances with respect to the indicated value. tq +25°C (CIE 121).

We reserve the right to make technical changes.

Targetti Sankey S.r.l.
Via Pratese, 164
50145 Firenze - Italy
Tel: +39 055 37911
targetti.com
targetti@targetti.com

CCIAA Firenze
Share Capital:
€ 500.000,00
VAT N. (IT):
01537660480
R.E.A.: FI-275656

TARGETTI

1T8313EL80 | CCTEVO DOWNLIGHT 160
 Recessed LED Downlight in a trim version

Accessories

Mounting System



L mm	Code
2500	1T9606

Anti-fall safety cable to secure the body of the appliance to the building structure.

Emergency Kit



Code
A059

Emergency kit composed of an inverter a LiFePO4 battery and a LED Green indicator. Allows permanent EP emergency use of the fixture it is connected to. The 1h or 3h autonomy can be selected by configuring the fixture. The batteries take 12h to completely recharge. LED Green indicator wired to the inverter through single-core cables L= 800mm. Emergency kit for fixtures that comply with EN 60598-2-22 standard, high risk areas excluded. Battery size 160x54x30 mm. Inverter size 165x40x25 mm.

Due to the technological evolution of the electronic components, the data provided may be updated, and as such, confirmation must be requested during the order process. Luminous flux and power supply have +/-10% tolerances with respect to the indicated value. tq +25°C (CIE 121).

We reserve the right to make technical changes.

Targetti Sankey S.r.l.
 Via Pratese, 164
 50145 Firenze - Italy
 Tel: +39 055 37911
 targetti.com
 targetti@targetti.com

CCIAA Firenze
 Share Capital:
 € 500.000,00
 VAT N. (IT):
 01537660480
 R.E.A: FI-275656

